

CITY OF LOWELL

PETITION

CITY COUNCIL

Gas Mains

William D. Blinn

*Prop to add to our existing gas
regulator station at 100th St and
intersection of Maple St &
Chalmers St.*

In City Council

October 1, 2019

Read and hearing ordered for 7PM on

October 15, 2019

**Read, Hearing Held,
Referred to Wire In-
spector, Development
Services**

City Clerk

Review of Utility Company Request for New Conduit/Pole Location

Applicant Information

Utility Gas Electric Telephone

Project Address

Intersection of Hale St at Chelmsford St opposite
 238 Hale St

(circle one) Other

Lowell, MA

Reason Reconstruction of gas pressure regulator station, associated piping, and installation of a SCADA system to comply with the latest National Grid safety standards

Date Submitted 9/18/19

Review done by John Gleason

Sidewalk Material

Note: material to be replaced in kind

Concrete Asphalt Other

Sidewalk Vaults present Y N U

Work on Street under a Paving Moratorium Y N U

Is this location within the Flood Plain? Y N U

Are ADA requirements being met? Y N U

Comments

1. Contractor shall notify adjacent property owners at least 72 hours prior to beginning work.
2. Contractor to loam and seed disturbed lawn area
3. Contractor to remove and reset any disturbed granite curbing
4. Contractor to coordinate with City Electrician in order to preserve municipal lighting and conduit in the work area.
5. Pavement restoration requirements: HMA sidewalks replaced in full width in compliance with ADA regulations. Restoration limits to be determined by City Engineer's office.

Outcome of Review

Approved

Approved with
Comments

Denied

Christine Clancy, P.E.; City Engineer

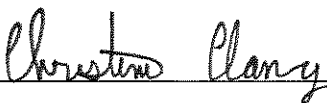

National Grid Contact
Christopher Maher, Senior Supervisor Gas Instrumentation and Regulation
Christopher.Maher@nationalgrid.com
Cell # 617-839-5435

Petition of:

National Grid
775 Dutton St.
Lowell, MA 01854

For the request to add to our existing gas regulator station a SCADA (Supervisory Control and Data Acquisition) System in the public right of way. The installation is located in the sidewalk at the intersection of *Hale St @ Chelmsford St*, across the street from *#238 Hale St*.

TO: Lowell City Clerks Office.

Respectfully represents the NATIONAL GRID of 775 Dutton Street, Lowell, Massachusetts, that it desires to install a remote SCADA telemetry cabinet at our existing gas pressure regulator station in the sidewalk at the intersection of *Hale St @ Chelmsford St*, across the street from *#238 Hale St*. The proposed installation will augment the existing regulator station with a new SCADA system, and provide real time pressure information to our gas control office, meeting National Grid's latest safety standards. This installation includes the necessary sustaining and protecting fixtures, under and across the public way hereinafter named.

Wherefore it prays that after due notice and hearing as provided by law, it be granted permission to excavate the public right of way to run and maintain a gas pressure SCADA telemetry cabinet, together with such sustaining and protecting fixtures as it may find necessary for the safe running operation of our underground gas structure and SCADA cabinet, said gas SCADA cabinet to be located substantially in accordance with the attached plan named – "Regulator Station SCADA Installation Station #2625 Hale St @ Chelmsford St."

NATIONAL GRID

BY 
Sr Supervisor Gas I&R

September 18, 2019

SEP 18 '19 PM 6:40
ENGINEERS

ORDERED:

Notice having been given and public hearing held, as provided by law, that National Grid be and it is hereby granted permission to excavate the public right of way to install the new SCADA cabinet as shown in the plan named "Regulator Station SCADA Installation Station #2625 Hale St @ Chelmsford St," under and across the public way hereinafter named as said Company may deem necessary, in public way or ways hereinafter referred to, as requested in petition with the said COMPANY dated, May 13, 2019.

Said gas telemetry SCADA cabinet shall be located substantially in accordance with the attached plan named - "Regulator Station SCADA Installation Station #2625 Hale St @ Chelmsford St."

The following are public ways along which the gas pressure regulator station above referred to may be installed: the sidewalk across the street from #238 Hale St on City Property, Lowell, Ma.

I hereby certify that the foregoing order was adopted at a meeting of the
....., held on the day of.....,20.....
.....|.....|....., 20.....

Received and entered in the records of location orders of the City of Lowell, Ma.

Book.....Page.....

Attest:

.....hereby certify that on20....., at o'clock,..... M
At....., a public hearing was held on the petition of
NATIONAL GRID for permission to install gas telemetry SCADA cabinet as described in the
order herewith recorded, and that I mailed at least seven days before said hearing a written notice
of the time and hearing to each of the owners of real estate (as determined by the last preceding
assessment for taxation) along the ways or parts of ways upon which the Company is permitted
to install gas telemetry SCADA cabinet under said order. And that thereupon said order was duly
adopted.

.....
.....
.....

nationalGrid

May 13, 2019

Lowell City Clerks Office
375 Merrimack St
Lowell Ma 01852

To whom it may concern:

Enclosed please find a petition of National Grid covering the installation of a gas telemetry SCADA cabinet.

If you have any questions regarding this permit please contact:

Christopher Maher
775 Dutton Street
Lowell, Ma 01854

Christopher.Maher@nationalgrid.com
Phone: 617-839-5435

If this petition meets with your approval, please return an executed copy to:

National Grid Contact:

Christopher Maher
775 Dutton Street
Lowell, Ma 01854

Christopher.Maher@nationalgrid.com
Phone: 617-839-5435

Very truly yours,

Christopher Maher
Sr Supervisor Gas Instrumentation and Regulation

REGULATOR STATION SCADA INSTALLATION

STATION #2625

HALE ST. @ CHELMSFORD ST. LOWELL, MA

W.O. NO.: 90000191294

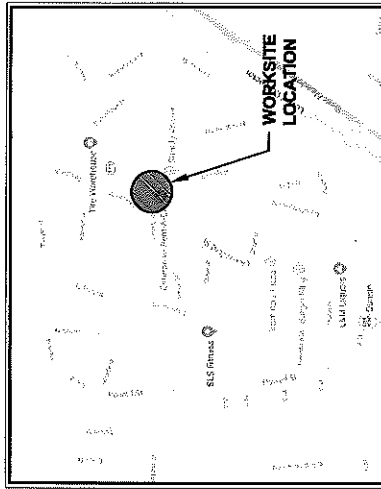

LOCUS
SCALE NTS

INDEX OF SHEETS		
SHEET	NAME	TITLE
1	GRS-LOW-191294-C-001	COVER SHEET
2	GRS-LOW-191294-C-002	CONSTRUCTION NOTES & DETAILS
3	GRS-LOW-191294-C-001	GENERAL ARRANGEMENT

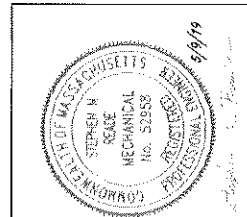

BOSTON GAS COMPANY d/b/a nationalgrid 40 SYLVAN ROAD WALTHAM, MA 02451		ISSUED FOR CONSTRUCTION	
SCADA INSTALLATION STATION #2625 HALE ST. @ CHELMSFORD ST. LOWELL, MASSACHUSETTS		COVER SHEET	
DWG SIZE	DESIGNER	ENGINEER	DATE
11'x17'	T. BOURQUE	R. KEGUS	05/09/2019
ASSET I.D.	ASSET I.D.	ASSET I.D.	ASSET I.D.
			2625
W.O. NO.:	90000191294		
PAGES OF 3 DRAWING NO.		SHEET NO. GRS-LOW-191294 C-001	

SCOPE OF WORK
 NATIONAL GRID SHALL BE RESPONSIBLE FOR THE DESIGN AND CONSTRUCTION OF ALL ELECTRICAL AND COMMUNICATIONS METALLICAL SYSTEMS AT AN EXISTING TELEPHONE STATION. NATIONAL GRID SHALL BE RESPONSIBLE FOR THE DESIGN AND CONSTRUCTION OF ALL ELECTRICAL AND COMMUNICATIONS METALLICAL SYSTEMS AT AN EXISTING TELEPHONE STATION. NATIONAL GRID SHALL BE RESPONSIBLE FOR THE DESIGN AND CONSTRUCTION OF ALL ELECTRICAL AND COMMUNICATIONS METALLICAL SYSTEMS AT AN EXISTING TELEPHONE STATION.

GENERAL NOTES
 1. THE CONTRACTOR SHALL BE RESPONSIBLE FOR OBTAINING ALL NECESSARY PERMITS FROM THE LOCAL, STATE, AND FEDERAL AUTHORITIES.
 2. THE CONTRACTOR SHALL BE RESPONSIBLE FOR OBTAINING ALL NECESSARY PERMITS FROM THE LOCAL, STATE, AND FEDERAL AUTHORITIES.
 3. THE CONTRACTOR SHALL BE RESPONSIBLE FOR OBTAINING ALL NECESSARY PERMITS FROM THE LOCAL, STATE, AND FEDERAL AUTHORITIES.

GENERAL NOTES
 4. THE CONTRACTOR SHALL BE RESPONSIBLE FOR OBTAINING ALL NECESSARY PERMITS FROM THE LOCAL, STATE, AND FEDERAL AUTHORITIES.
 5. THE CONTRACTOR SHALL BE RESPONSIBLE FOR OBTAINING ALL NECESSARY PERMITS FROM THE LOCAL, STATE, AND FEDERAL AUTHORITIES.

GENERAL NOTES
 6. THE CONTRACTOR SHALL BE RESPONSIBLE FOR OBTAINING ALL NECESSARY PERMITS FROM THE LOCAL, STATE, AND FEDERAL AUTHORITIES.
 7. THE CONTRACTOR SHALL BE RESPONSIBLE FOR OBTAINING ALL NECESSARY PERMITS FROM THE LOCAL, STATE, AND FEDERAL AUTHORITIES.

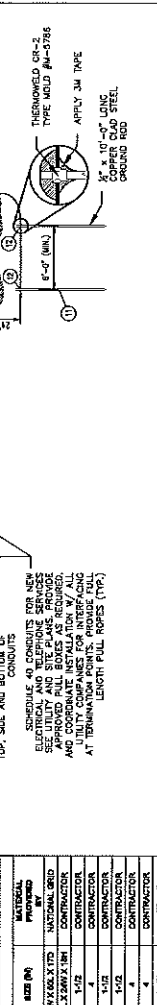
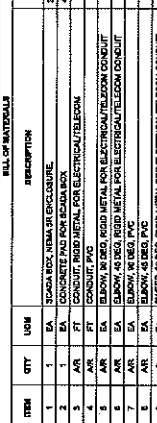
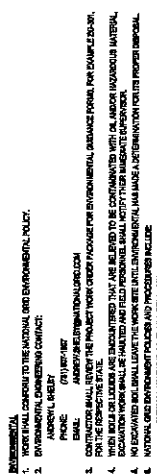
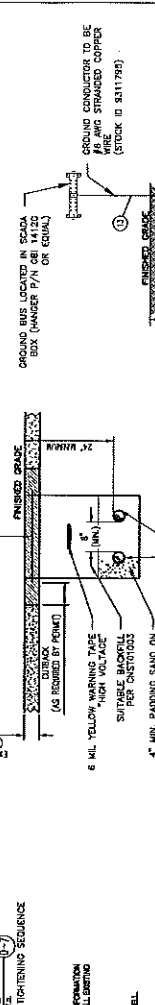
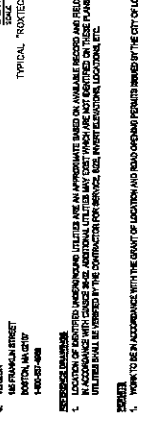
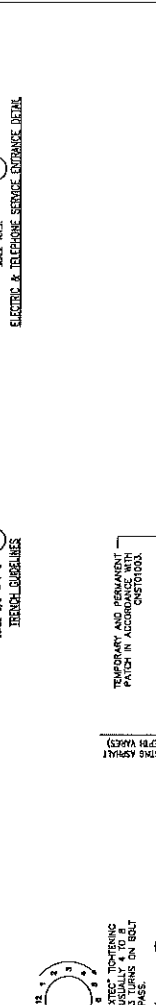
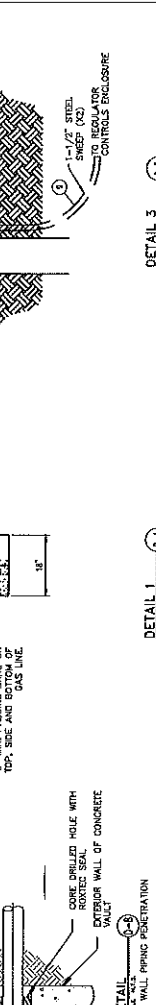
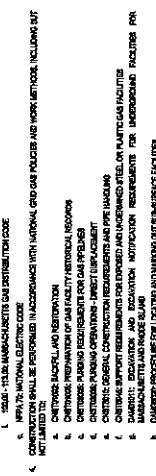
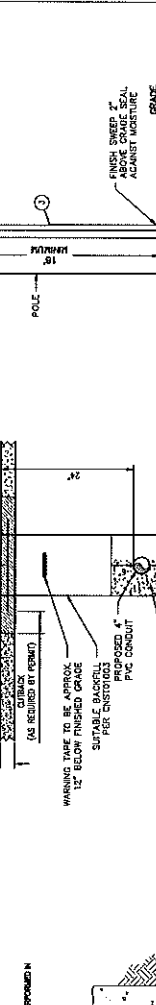
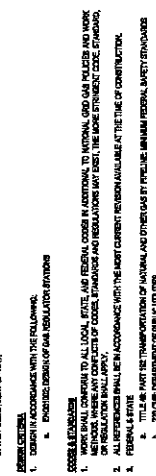

ITEM	QTY	UNIT	DESCRIPTION	SIZE (IN)	MATERIAL
1	1	EA	200' X 60' X 12' CONCRETE	200' X 60' X 12'	CONCRETE
2	1	EA	200' X 60' X 12' CONCRETE	200' X 60' X 12'	CONCRETE
3	1	EA	200' X 60' X 12' CONCRETE	200' X 60' X 12'	CONCRETE
4	1	EA	200' X 60' X 12' CONCRETE	200' X 60' X 12'	CONCRETE
5	1	EA	200' X 60' X 12' CONCRETE	200' X 60' X 12'	CONCRETE
6	1	EA	200' X 60' X 12' CONCRETE	200' X 60' X 12'	CONCRETE
7	1	EA	200' X 60' X 12' CONCRETE	200' X 60' X 12'	CONCRETE
8	1	EA	200' X 60' X 12' CONCRETE	200' X 60' X 12'	CONCRETE
9	1	EA	200' X 60' X 12' CONCRETE	200' X 60' X 12'	CONCRETE
10	1	EA	200' X 60' X 12' CONCRETE	200' X 60' X 12'	CONCRETE
11	1	EA	200' X 60' X 12' CONCRETE	200' X 60' X 12'	CONCRETE
12	1	EA	200' X 60' X 12' CONCRETE	200' X 60' X 12'	CONCRETE
13	1	EA	200' X 60' X 12' CONCRETE	200' X 60' X 12'	CONCRETE
14	1	EA	200' X 60' X 12' CONCRETE	200' X 60' X 12'	CONCRETE
15	1	EA	200' X 60' X 12' CONCRETE	200' X 60' X 12'	CONCRETE

ITEM	QTY	UNIT	DESCRIPTION	SIZE (IN)	MATERIAL
1	1	EA	200' X 60' X 12' CONCRETE	200' X 60' X 12'	CONCRETE
2	1	EA	200' X 60' X 12' CONCRETE	200' X 60' X 12'	CONCRETE
3	1	EA	200' X 60' X 12' CONCRETE	200' X 60' X 12'	CONCRETE
4	1	EA	200' X 60' X 12' CONCRETE	200' X 60' X 12'	CONCRETE
5	1	EA	200' X 60' X 12' CONCRETE	200' X 60' X 12'	CONCRETE
6	1	EA	200' X 60' X 12' CONCRETE	200' X 60' X 12'	CONCRETE
7	1	EA	200' X 60' X 12' CONCRETE	200' X 60' X 12'	CONCRETE
8	1	EA	200' X 60' X 12' CONCRETE	200' X 60' X 12'	CONCRETE
9	1	EA	200' X 60' X 12' CONCRETE	200' X 60' X 12'	CONCRETE
10	1	EA	200' X 60' X 12' CONCRETE	200' X 60' X 12'	CONCRETE
11	1	EA	200' X 60' X 12' CONCRETE	200' X 60' X 12'	CONCRETE
12	1	EA	200' X 60' X 12' CONCRETE	200' X 60' X 12'	CONCRETE
13	1	EA	200' X 60' X 12' CONCRETE	200' X 60' X 12'	CONCRETE
14	1	EA	200' X 60' X 12' CONCRETE	200' X 60' X 12'	CONCRETE
15	1	EA	200' X 60' X 12' CONCRETE	200' X 60' X 12'	CONCRETE

ITEM	QTY	UNIT	DESCRIPTION	SIZE (IN)	MATERIAL
1	1	EA	200' X 60' X 12' CONCRETE	200' X 60' X 12'	CONCRETE
2	1	EA	200' X 60' X 12' CONCRETE	200' X 60' X 12'	CONCRETE
3	1	EA	200' X 60' X 12' CONCRETE	200' X 60' X 12'	CONCRETE
4	1	EA	200' X 60' X 12' CONCRETE	200' X 60' X 12'	CONCRETE
5	1	EA	200' X 60' X 12' CONCRETE	200' X 60' X 12'	CONCRETE
6	1	EA	200' X 60' X 12' CONCRETE	200' X 60' X 12'	CONCRETE
7	1	EA	200' X 60' X 12' CONCRETE	200' X 60' X 12'	CONCRETE
8	1	EA	200' X 60' X 12' CONCRETE	200' X 60' X 12'	CONCRETE
9	1	EA	200' X 60' X 12' CONCRETE	200' X 60' X 12'	CONCRETE
10	1	EA	200' X 60' X 12' CONCRETE	200' X 60' X 12'	CONCRETE
11	1	EA	200' X 60' X 12' CONCRETE	200' X 60' X 12'	CONCRETE
12	1	EA	200' X 60' X 12' CONCRETE	200' X 60' X 12'	CONCRETE
13	1	EA	200' X 60' X 12' CONCRETE	200' X 60' X 12'	CONCRETE
14	1	EA	200' X 60' X 12' CONCRETE	200' X 60' X 12'	CONCRETE
15	1	EA	200' X 60' X 12' CONCRETE	200' X 60' X 12'	CONCRETE

NO.	DESCRIPTION	DATE	ISS. BY	CHK. BY	DATE	ISS. BY	CHK. BY
0	ISSUED FOR CONSTRUCTION	02/09/2018	TRE	RK	02/09/2018	SMR	SMR

NO.	DESCRIPTION	DATE	ISS. BY	CHK. BY	DATE	ISS. BY	CHK. BY
0	ISSUED FOR CONSTRUCTION	02/09/2018	TRE	RK	02/09/2018	SMR	SMR

SCADA INSTALLATION
 STATION #2625
 HALE ST. CHELMSFORD ST.
 LOWELL, MASSACHUSETTS

CONSTRUCTION NOTES & DETAILS

DESIGNER: I. BOUQUE
 ENGINEER: R. KELGIS
 DATE: 05/09/2018
 ASSET ID.: 2625
 W.O. NO.: 90000191294

SCADA COMPANY
 67974
nationalgrid
 40 SYLVAN ROAD
 WALTHAM, MA 02457

ISSUED FOR CONSTRUCTION

PAGE OF 3
 DRAWING NO. GRS-LOW-191294
 SHEET NO. G-002

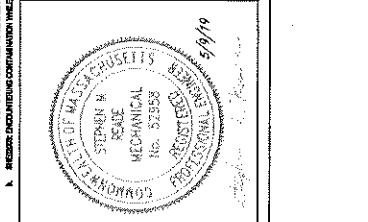

CHELMSFORD STREET

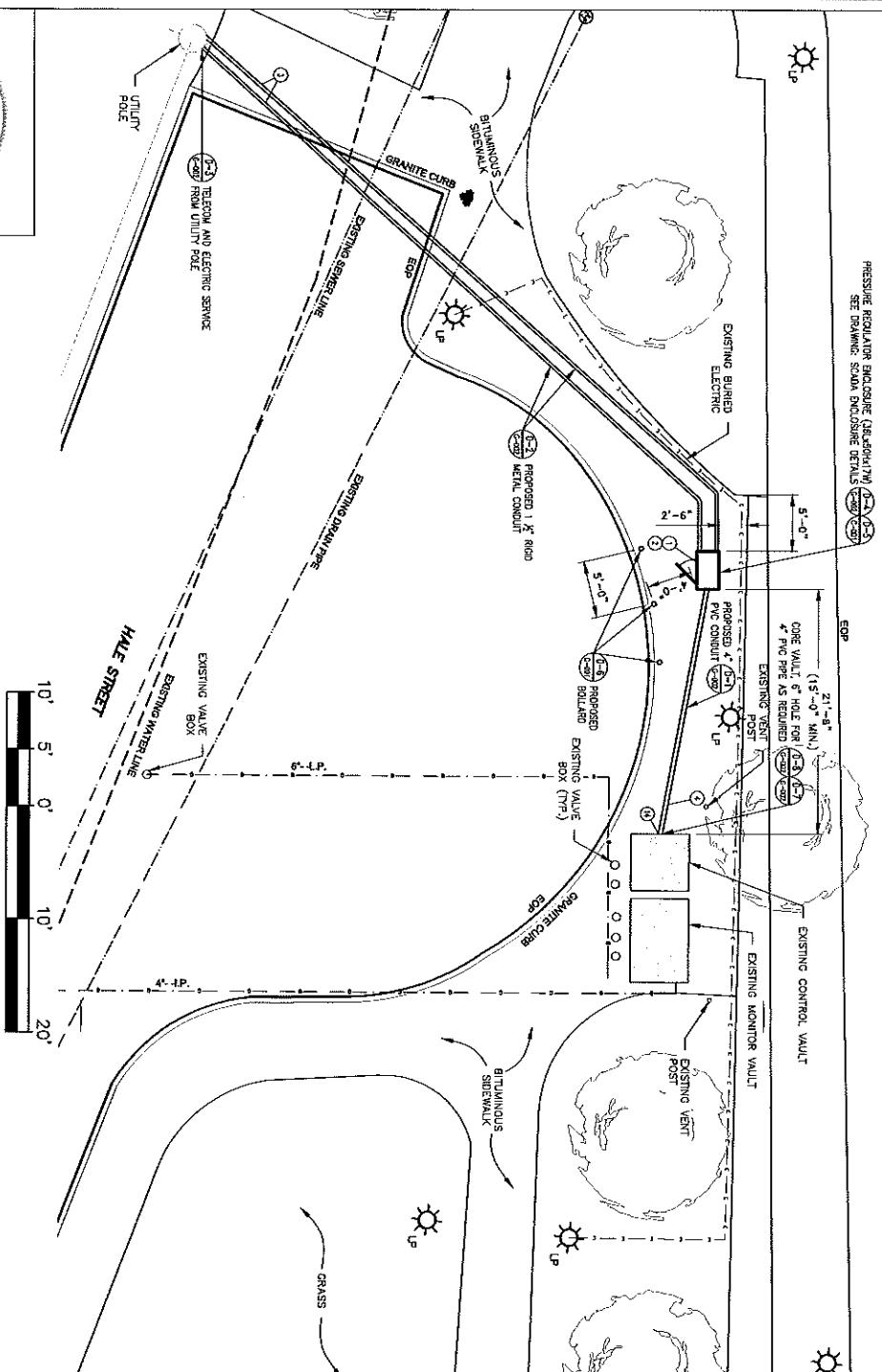

SCALE 1" = 10'-0"

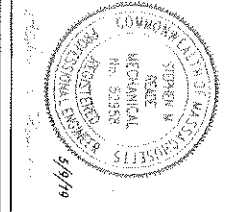
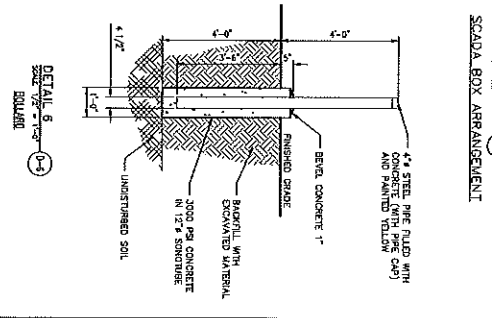
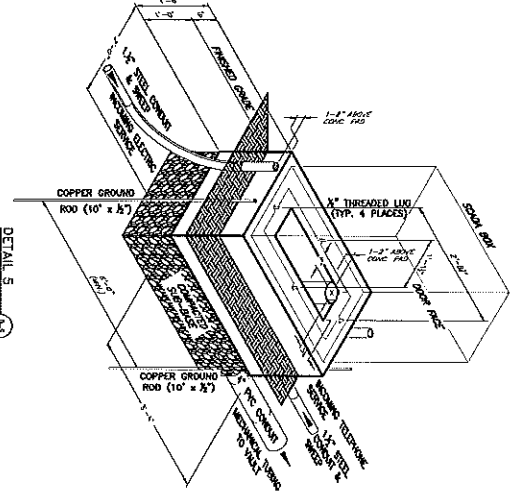

NO.	ISSUED FOR CONSTRUCTION	DESCRIPTION	DATE	DRN	CHKD	APP'D
0	ISSUED FOR CONSTRUCTION		05/09/2019	TR	RK	SLR

BOSTON GAS COMPANY
 4/2/19
nationalgrid
 40 STYAN ROAD
 WALTHAM, MA 02461

DMG SIZE	DESIGNER	ENGINEER	DATE	ASST. I.D.	W.O. NO.
11 X 17	T. BOUQULE	R. KELGUS	05/09/2019	2625	90000191294

SCADA INSTALLATION
 STATION #2625
 HALE ST. @ CHELMSFORD ST.
 LOWELL, MASSACHUSETTS

GENERAL ARRANGEMENT

PAGE OF 3
 DRAWING NO. GRS-LOW-191294
 SHEET NO. C-001